

Perfusor® Space PCA and Accessories



Rx only

Instructions for Use

CE 0123

US

B | BRAUN

CONTENTS

Perfusor® Space PCA Overview.....	3
Patient Safety	5
Menu Structure / Overview	7
Menu Structure / Navigation.....	8
Chapter 1 Operation.....	10
1.1 PCA Operation.....	10
1.2 PCA Accessories.....	11
1.3 Infusion Start.....	13
1.4 Entries with different combinations of Rate, VBTI, and Time.....	14
1.5 Bolus Application.....	15
1.6 Syringe Change and New Therapy Start.....	15
1.7 End of Infusion.....	16
1.8 Standby Mode.....	17
Chapter 2 Advanced Operations.....	18
2.1 Status Request of Pump when Infusion is Running.....	18
2.2 Rate, VBTI and Time Change Without Infusion Interruption and Reset of Status Menu Data	18
Chapter 3 Special Functions*	19
3.1 Dose Rate Calculation (Overview)	19
3.2 Dose Rate Calculation (Operation).....	19
3.3 Drug Library.....	20
3.4 Instructions for Use of Bar-coding using DoseScan™ and the SpaceStation with SpaceCom.....	21
Chapter 4 Options.....	26
4.1 Occlusion Pressure.....	26
4.2 Data lock	26
4.3 Bolus Rate.....	27
4.4 KVO Mode	27
4.5 Contrast / Display Illumination / Keypad Illumination.....	28
4.6 Alarm Volume.....	28
4.7 Date / Time	28
4.8 Macro Mode	28
Chapter 5 Alarms	29
5.1 Device Alarm.....	29
5.2 Pre-Alarms and Operating Alarms.....	29
5.3 Reminder Alarms.....	32
5.4 Alarm Instruction.....	32
Chapter 6 Battery Operation and Maintenance	33
Chapter 7 Compatible Syringes	35
Chapter 8 Start Up Graphs and Trumpet Curves.....	37
Chapter 9 Technical Data	38
Chapter 10 Warranty / TSC** / Service / Training / Cleaning / Disposal.....	40
Chapter 11 Instructions for Use Accessory	42
Ordering	45
Technical Support.....	46

* The availability of individual performance features depends on the pump configuration.

** Technical Safety check.

PERFUSOR® SPACE PCA OVERVIEW

Up and down arrow buttons

Used for scrolling menus, changing settings from 0-9, answering yes/no questions.

Right and left arrow buttons

Used for selecting scale values and switching between fields when entering numbers. Press the left arrow button to start a function while the infusion is in operation or to restart when it is interrupted.



Yellow LED: Pre-alarm, reminder alarm
 Green / Red LED: Infusion occurring / device alarm, operating alarm
 Blue LED: Connection to SpaceControl

Press to reset individual numbers to zero and returns to most recent display or menu level



Drive head with claw mechanism to hold the syringe plunger plate

Emergency release button on the outside of drive head.

Press to turn pump ON/OFF.



Press to initiate bolus.



Confirms functional selection, certain values /settings /alarms.



Press to assign a barcode scan to the pump after scanning.



Press to Start/Stop the infusion.

The syringe holder locks the syringe in position. To remove the syringe, pull and turn to the right. The drivehead automatically retracts.

Battery compartment cover

Prior to changing the battery, always disconnect from patient and turn off the pump. Press the tab under the battery compartment cover using a small object (e.g. a pen) and remove the cover from the pump. Slide the green battery locking clip back and remove battery to replace.



P3 port for future options

P2 port for AC adapter, SpaceStation, SP connection cable (12V), combination cable and additional accessory cables (staff call, service)

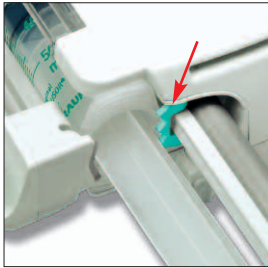

Syringe setting

Pull syringe holder and turn to the right to open the green syringe guide (see red arrow). Syringe must be mounted with flange upright into the slot next to the green syringe guide before the syringe holder is closed. Make sure that the syringe is properly held in place.

Caution: Do not touch the parking brake when removing from the syringe holder.

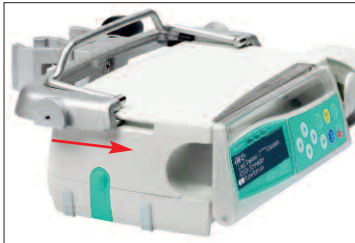

Attaching the pole clamp (universal clamp)

Align pole clamp guide slots on the pump with the arms of the pump slots and pole clamp and slide forward until the locking mechanism snaps in place.

To remove, press the release button on the frame, press the handle down and remove the pole clamp.



Transport

A maximum of three pumps may be locked together on one pole clamp.

Lock devices to one another

Slide the rails of top pump onto slots of bottom pump until they audibly snap in and the green buttons are aligned on top of one another. To separate the units, press the green locking button on the top pump and slide bottom pump forward.

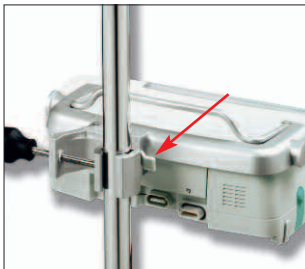

Attachment to IV pole

Place the pole clamp opening around the IV pole and tighten the screw. Loosen the screw to remove it. To rotate the pump and pole clamp, press the lever (see red arrow) and turn in one of the two directions until the lever clicks into the notch. Press lever to rotate.

Caution: Do not lean against the pump as a support while it is attached to the stand!

PATIENT SAFETY



Prior to operation, read the user manual. The device should be operated by trained personnel only and should be checked regularly.



Caution: Federal Law restricts this device to sale by or on the order of a physician.

Intended Use

The Perfusor® Space PCA Infusion Syringe Pump System is an electrical, external, syringe infusion pump system indicated for use with adults, pediatrics, and neonates and is intended to provide infusions of parenteral fluids/medications, blood and blood products indicated for infusions through FDA approved routes of administration.

Operation

- Introductory training on the use of the Perfusor® Space PCA must be conducted by B. Braun sales representatives or other authorized persons. After each software update, users need to obtain instruction in the user manual on the updates to the device and accessories.
- Make sure that the device is properly positioned and secured. Do not mount pump above patients.
- Prior to start-up, check the device and especially the green syringe guide for possible damage. Make note of audio and visual alarms during the self-test.
- Do not connect to the patient until the syringe has been properly inserted and the syringe plunger plate is properly gripped by the claw on the drive head. Disconnect from the patient when changing the syringe in order to avoid unwanted drug administration.
- Only use appropriate syringes listed in the syringe table on page 35.
- Position the tubing so that it is free of kinks.
- We recommend replacing disposables per CDC guidelines and/or based on institutional protocols.
- In rooms for medical use, installation must comply with the regulations (e.g. VDE 0100, VDE 0107 or IEC provisions). Observe any country-specific regulations or variations.
- To avoid an explosion, the pump must never be operated in the presence of flammable anesthetics.
- Compare values displayed with values entered. Only begin infusion if the values match one another.
- When using the nurse call feature, we recommend checking the system after connecting it.
- Protect the pump and the AC adapter from moisture.
- Do not hold the pump by the drive head when transporting.
- If the pump is dropped or is exposed to force, it must be checked by the the biomedical engineering department.
- The user must always review the data displayed before making further medical decisions.

- For mobile use (homecare, inpatient and outpatient transport), make sure the device is securely mounted and positioned. Changes in location and rough jolts can result in minor changes in the delivery characteristics.
- For life-supporting drugs, additional patient monitoring is strongly advised.
- To prevent the alarm from sounding in error, do not apply force on the drive head when drugs are being administered.
- When administering critical drugs, a second pump for the drug should be kept available.
- Regardless of the soft limits, the values entered for the patient must be medically appropriate.
- In the event that values in the dose rate calculator are changed, the flow rate is automatically updated and the dose rate is fixed.

Enteral Nutrition

The Perfusor® Space may be used for enteral nutrition, too. Do not use enteral fluids for intravenous infusion as this may harm your patient. For this reason only use disposables dedicated and labelled for enteral nutrition.

Other components

- Check the devices and drugs for possible incompatibilities in the respective manufacturers' literature.
- Only use luer lock fittings and syringes as well as compatible combinations of devices, accessories, replacement parts and disposables.
- Connected electrical components must satisfy IEC/EN specifications (e.g. IEC/EN 60950 for data processing devices). The system administrator who connects additional devices to the system must adhere to the IEC/EN 60601-1-1 standard.
- If multiple devices/infusion lines are connected, a risk of adverse interactions should be considered.







Safety Standards

The Perfusor® Space PCA meets all safety standards for medical electrical devices in compliance with the publications IEC/EN 60601-1 and IEC/EN 60601-2-24.

- The EMC limit values (electro-magnetic compatibility) are in compliance with IEC/EN 60601-1-2 and IEC/EN 60601-2-24. When operating in the vicinity of devices that may cause higher interference emissions (e.g. HF surgical devices, cell phones, etc.), the safety distances recommended for these devices must be observed.
- The Perfusor® Space PCA meets the relevant requirements of EN 13718 to be able to be used in the air, on the water, in difficult terrain. During transport, the Perfusor® Space PCA has to be mounted on a suitable mounting system by using the SpaceStation or pole clamp SP. If the Perfusor® Space PCA is stored in temperature ranges below the defined operating conditions, it must be returned to room temperature for at least an hour prior to operating.

MENU STRUCTURE / OVERVIEW

Cutline

-  ON/OFF button
 -  Start/Stop button
 -  Bolus button
 -  Clear button
-  OK button
 -  Keypad with up, down, right, and left arrow buttons
 -  Connection button

Menu Structure

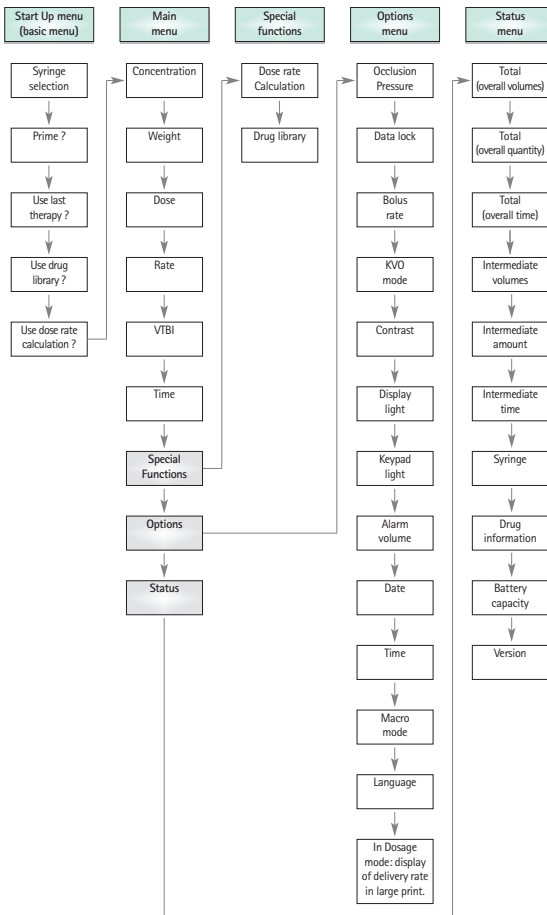

The pump can be customized to the user's needs by deactivating the functions of the start-up and option menus as well as the bolus function via the service program.

MENU STRUCTURE / NAVIGATION

Display

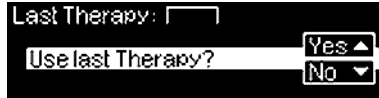

Explanations

The current therapy is displayed on the top display line. Yes/no questions can be answered by pressing for yes or for no.

Parameters that can be changed (e.g. rate in mL/h), are opened with or . Edit parameters, change location/levels with . White background displays current location/level. Use and to change current setting. Help text on the top/bottom display line shows options (e.g. confirm rate with , start infusion with or delete rate with).

Typical display during operation:

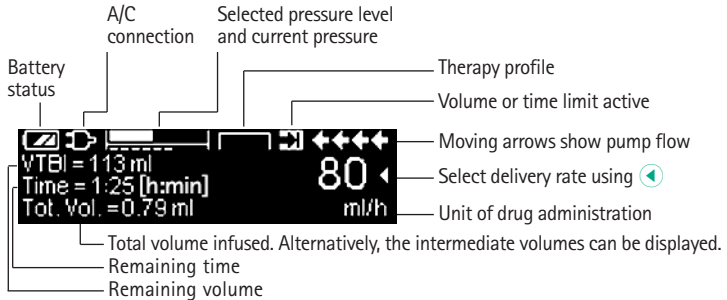

All status information is available in the bottom display line. The desired information can be selected by using or and afterward is displayed continuously (e.g. complete drug name, time until syringe is empty, etc.).

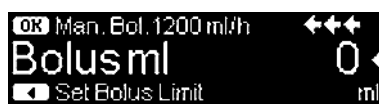

was pressed during drug administration. Manual bolus can start with 1200 mL/h by pressing the (see top display line) or continue by entering a bolus limit with (see bottom display line).

Display

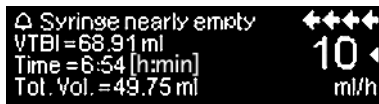

Explanations

This message is displayed if an attempt is made to change a value with without authorization.

Select pressure level with or and confirm with . Cancel entry with .

Pre-alarms are displayed by a message on the display (e.g. "syringe almost empty"), a signal tone and a blinking yellow LED. Confirm the pre-alarm with .

With an operating alarm (e.g. "syringe empty") the infusion stops, a signal tone sounds and the red LED blinks. Confirm alarm with . Confirmation does not generate audible feedback.



By pressing and holding , a white bar expands from left to right, counts down 3 seconds, then the pump turns off. As long as a syringe is inserted, the pump does not turn off; instead it goes to "standby mode." A standby period of up to 24 hours can be entered.

OPERATION

1.1 PCA Operation

Requires a drug library with at least one drug that is approved for the PCA profile. The profile defines conditions that make an effective and safe therapy possible.

Turn on pump with  and wait for self-test. Depending on the pre-settings, the option of selecting a drug appears directly or the pump displays the main menu.



From the main menu, select special functions by pressing  and confirm with .

Press  to select drug library, category and preferred drug.



After making your selection, the pump displays the drug-specific information that is confirmed by pressing .



Select the "PCA" profile by pressing  and confirm with . The therapy settings from the drug library are displayed*.

The therapy can be started now with  in case all values are defined.

Depending on the pre-defined settings, the therapy may start with an initial bolus and/or basal rate.

Before exiting patient mode, the pump has to be put in DataLock Level 3 by pressing  in the options menu to prevent unauthorized access to the settings. Data lock is especially designed for PCA operation.

The code is entered with  and confirmed with .



The pump display shows the adjacent information.

*Bolus volume is the volume of single bolus the patient may request. Max Limit is the amount of the drug or volume a patient may request within a certain time in total. Lockout is the time in between each bolus request when further doses are not allowed.

In this mode, the patient can request boluses, which are administered or rejected according to the current status of the therapy. A syringe change is also possible after entering the code for Level 1 and 2. A modification of the PCA parameters is, however, only possible for Level 3.

You can check the therapy's status via the "status" menu.

Press  in the main menu and then  in the status menu.

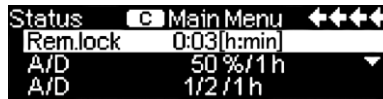

The A/D percentage indicates what percentage of the requested doses were actually administered, thus providing information concerning the effectiveness of the therapy.

By pressing , a confirmation beep for requesting a bolus can be activated and its volume adjusted in Level 3.

If a patient bolus cord button is connected, this is indicated by the therapy symbol .

If a bolus cord is not connected, the therapy symbol looks like this .

The patient bolus cord is connected to the P2 port on the back of the pump.

Note: It is possible to initially administer a drug that is scheduled both for the PCA and for continuous application and then switch over to the PCA later.

1.2 PCA Accessories

The Perfusor® Space PCA Kit includes the following accessories:



Space PCA Kit (Ref 8712554)

Consists of :

- Patient demand bolus cord
- Velcro strap for attaching the bolus cord around the patient's arm
- Clip to attach the bolus cord to the Velcro strap
- Metal clip for attaching the bolus cord to the bed sheet
- Cable strap for wrapping the cable of the bolus cord
- PCA-Key for locking the syringe holder or the Syringe Anti Removal Cap



Velcro strap and clip to attach the bolus cord around the patients arm.



Metal clip for attaching the bolus cord to the bed sheet.



Usage of the cable strap for wrapping the cable of the bolus cord.





Syringe Anti Removal Cap PSP (8713556)

The Syringe Anti Removal Cap PSP is slid over the drive head from the front and is locked with the PCA-key by turning the key in a 270° clockwise rotation. View the markings on the cap to ensure it is securely locked. Dismantling: rotate key 270° counter clockwise. Push to the left and disengage.

Caution: When Syringe Anti Removal Cap is used always change the syringe as soon the "syringe empty" alarm appears.

1.3 Infusion start





- Make sure the pump is properly installed. If the device is connected to the power supply, the display shows the battery status, the power supply icon and the most recent therapy.
- Press  to turn the device on. Note the automated self-test – "Self-test active" – and the software version are displayed; two signal tones sound and all three LEDs (yellow, green/red and blue) light up once. Information concerning power supply (A/C or battery operation), the adjusted pressure level and the syringe type (if the syringe is already inserted) are displayed. Afterward, the drive head retracts..
- Press  to begin entering the therapy parameters or to open the pump cover and syringe holder to insert the syringe.
- Insert the syringe with the syringe flange in a vertical position in the slot to the right of the housing. Then close syringe holder and pump cover. Piston Brake moves forward.

Caution: Never leave the pump unattended when inserting the syringe.



- Confirm syringe type with . Syringe type displayed must match the syringe inserted.
- Drive head moves forward and grabs the plunger plate of the syringe.



Caution: Keep hands away from the moving drive.

Note: Make sure that the piston brake returns to the syringe holder.

- If the prime function is activated, press  in order to prime the infusion line at the rate shown in the display. Cancel prime function by pressing . Repeat process until the line is completely bled. Then press  to continue.
- Connect to patient.
- If necessary, answer questions in the start-up menu with  and  until the rate in the main menu appears.

Adjust delivery rate:

- Press  and enter rate using .
- Press  to start infusion. Continuous arrows on the display and green LED show drug being administered.









Note: Continuous infusion can be canceled at any time by pressing . The pump can be turned off at any time by pressing  for 3 seconds (exception: data lock levels 2 and 3 or a disposable is loaded).

1.4 Entries with different rate, volume to be infused and time combinations

The Perfusor® Space PCA allows a volume and time limit to be entered in addition to the delivery rate. If two of these parameters have been entered, then the pump calculates the third parameter. If a volume and/or a time is pre-selected, an arrow symbol is placed in front of one of these parameters in the main menu. This is called the "target." While the pump delivers the drug, this target symbol appears next to the continuous display arrows on the display. From it, you can see that the pump has been programmed either with a volume or a time limit. The target symbol visible in the main menu shows the parameters (volume or time) for that therapy. In case of changes to the delivery rate, the target parameter is generally not adapted to the new flow rate; rather the parameter is recalculated in front of which no target symbol appears. After the infusion starts, the remaining volume and time values are displayed (values count backwards) in the main menu as well as the delivery display.

- 1) Enter volume to be infused and time. Delivery rate is calculated and displayed on the bottom left on the display.

Target: Volumes

- Select Volume with  and open with .
- Enter Volume with  and confirm with .
- Select time with  and open with .
- Enter time with  and confirm with .

Continue in the same way to calculate 2.) and 3.).

- 2) Infusion with volume limit

Enter rate and volume to be infused: The infusion time is calculated and displayed at the bottom left in the display.

Target: Volume

- 3) Infusion with time limit

Enter rate and time: The volume is calculated and displayed at the bottom left in the display.

Target: Time













Changing of volume to be infused and time already entered (rate, volume and time were already entered at the time of the change):



- a) Target symbol located in front of volume to be infused:
 - Changing volume to be infused => Changing the time. Old and new target: Volume to be infused.
 - Change in time => Changing the rate. Old and new target: Volume to be infused.
- b) Target symbol is located in front of time:
 - Change in time => Changing the volume to be infused. Old and new target: Time.
 - Change in volume => Changing the time. New target: Volume to be infused.

Note: Change in volume and time only possible if the pump has been stopped.



1.5 Bolus Application

There are three different options to administer a bolus:



- 1) Press manual bolus: . Then press  and hold button down. Bolus is delivered as long as the button is pressed down. Bolus volume delivered is displayed.
The maximum bolus volume is 10% of the syringe size or 10 seconds.
If this limit is reached, an audible signal follows.
- 2) Bolus with volume pre-selection: Press , press  and select bolus limit . Press  to confirm and start the bolus. Regardless of the service program settings, an audible signal sounds after at completion of the bolus.
- 3) Bolus with rate calculation: Press , press  and select bolus dose by pressing . Press  to confirm the bolus dose. Time in which the bolus should be administered, select by pressing . Calculated bolus rate is displayed on the top display line. Press  to confirm and start the bolus.

After the  is pressed, the bolus unit can be selected by pressing . This selected unit is stored and used in the future as the default. This means that it is also possible to administer a bolus in mL in the dosage calculation mode.

A default and a maximum bolus rate can be specified via the service program. But the device always returns to the default rate at each startup, even if the bolus rate was previously changed manually.

Note: If a bolus cannot be administered after pressing , the pump automatically returns to the delivery display. If a bolus is not completed, the device issues a reminder alarm that has to be confirmed by pressing .



Note: For a bolus with a pre-selected volume, the volume counts up.

The pump can be primed at any time by pressing  while the pump is stopped. Answer the following question by pressing  in order to start the priming process. Cancel by pressing  or any other button.

Caution: Do not overdose! At a bolus rate of 1200 mL/h, for example, 1 mL is reached after 3 seconds. Press  to cancel bolus at any time. For low bolus volumes, under dosages cannot be ruled out due to the start-up characteristics of the pump and tolerances in the infusion system. Disconnect patient while priming the system.

1.6 Syringe change and start of new therapy





Note: Always disconnect the patient from the device before changing the syringe to prevent an unintended dose. Never leave the pump unattended while replacing the syringe. Before a new syringe is inserted, check the functionality of the green syringe guide.

- Press  to stop drug delivery. The green LED disappears. Disconnect patient from device.
- Open syringe holder. The drive retracts. If the syringe holder is pulled more than 30 seconds after the pump was stopped, you have to first answer the question of whether to replace a syringe by pressing  before the drive returns (regardless of the time, this always applies in the case of a syringe replacement alarm). If the syringe holder is only briefly pulled (less than a second), answer the question displayed first by pressing  to release the plunger shaft.
- Open front cover, remove syringe and insert new one.





Note: When removing the syringe, in the event that the plunger plate is not released by the claw, press the emergency release button to unlock the claw on the drive head. The emergency release button is located on the exterior of the drive head. It can be released by pressing with a pointed object (e.g. a pen). The claw can then be opened manually and the syringe removed. The device should then be sent to service for repair.

- Close the syringe holder and pump door (**Note:** Plunger brake must move forward) and confirm the syringe type inserted by pressing . Drive moves forward and grabs the plunger plate of the syringe.

Note: Do not allow objects to block moving drive. Plunger brake must return automatically to the syringe holder.



- If necessary, prime pump by pressing , then press  to continue.
- Connect patient and check parameters by pressing .
- Begin infusion by pressing .

To start a new therapy after replacing the syringe:

- If the pump is in the main menu, press .
- Press  and enter new therapy parameters by pressing .
- Begin infusion by pressing .

Note: A new therapy can be started at any time during a stopped infusion. If a pump is in the main, status or option menu, press  (repeatedly) and follow the instructions as described.

1.7 End of infusion











- Press  to stop infusion. The green LED goes out. Disconnect patient from device.
- Open syringe holder. Answer question of whether the syringe holder should be opened by pressing . The drive retracts.
- Open pump door. Remove syringe, put syringe holder in an upright position and close cover.

- Press  for 3 seconds to turn off pump. Drive automatically parks near the pump housing.

Note: The device permanently retains the settings after it is turned off. As long as a syringe is inserted, the "standby mode" is used.





1.8 Standby

In case of a longer delay, the user has the option of retaining the set values.





- Interrupt the infusion by pressing . Afterward, press  for less than 3 seconds.
- Confirm whether pump should be switched to standby by pressing .
- The current setting for standby is displayed. Accept the default setting by pressing  or change by pressing  (0–24 hours) and confirm with .
- As long as the pump is in "standby," the name of the drug and the remaining time for "standby" are displayed. The remaining time can be changed with . Exit "standby" with .
- As long as a syringe is inserted, the pump remains in "standby" mode. By pressing , the system exits "standby." By pressing , the "standby" duration is entered.

ADVANCED OPERATIONS

2.1 Querying the pump status during the infusion





While the device is pumping, you can switch between the delivery display and the main menu by pressing  and navigate through the menu by pressing  to check the parameters. To check the menu items in the status and options menu, select "status" or "options" in the main menu, select with  and scroll through the menu . All status information is also available, if needed, in the bottom line of the main screen.



2.2 Rate, volume and time change without infusion interruption and resetting of status menu parameters

- If the pump is in the delivery display mode, press  to switch to the main menu. Select Rate/Volume/Time with  and press  to open parameters.
- Enter new value with  and confirm with .

Reset status menu parameters:

The intermediate volume and time parameters can be cleared while the pump is pumping or the infusion is interrupted.

- Select "status" in the main menu by pressing  and press .
- Select intermediate volume (in mL) or interim time (in h:min) by highlighting with  and select parameters by pressing .
- Reset values by pressing .

Both total volume and time parameters are displayed as "total" using the appropriate unit and can be reset by starting a new therapy. Second reset method: If the pump is in the main menu: Press , answer the question concerning the most recent therapy used by pressing  and then reset the values with .

The type of syringe inserted can be viewed under the menu item "Syringe" and cannot be changed after confirming the syringe item at the beginning of the infusion. The "Drug info" menu item lists the drug name, the name of the drug library and its creation date. The current battery capacity is displayed in hours and minutes in "Battery capacity" menu item and the current software version under "Version."

SPECIAL FUNCTIONS

3.1 Dosage calculation (Overview)















The dose rate calculation allows the delivery rate to be calculated in mL/h from the dosage parameters entered.



$$\text{Infusion rate [mL/h]} = \frac{\text{Dose}}{\text{Concentration}} \times [\text{Patient weight (optional)}]$$

Setting parameters:

1. Concentration as dosage of active ingredient per volume
 - a. Dosage in µg, mg, mmol, IE or mEq.
 - b. Volume in mL.
2. If necessary, patient weight in kg or lbs
3. Dose prescription:
 - a. According to time in dosage per min, hour or 24 hour.
 - b. According to time and patient weight in dosage per kg per min, h or 24h.

3.2 Dose Rate calculation (Application)

- Select dosage calculation with .
- Select the unit of the dosage by pressing  and confirm with .
- Enter the concentration by entering dosage and volume. Enter the values by pressing  and confirm with .
- If no weight is entered, press . For a time- and patient-related calculation, press , enter the patient weight with  and confirm with .
- Select the dose prescription by pressing  and confirm with .
- Enter the dosage with  and confirm with . The rate is automatically calculated and is displayed at the bottom of the screen.
- Verify the calculated rate displayed and the parameters, if necessary, by pressing  prior to start of the infusion with the .

Concentration and dosage can be changed in the main menu at the same time as rate, volume and times are changed (see 2.2). The effects of dosage modifications on other parameters are displayed in the bottom line of the display. The total and interim quantity of the drug administered can be additionally found in the status menu. These can be checked and reset at the same time as the total and interim values. It is possible to deactivate the dosage calculation in the Stop mode by pressing  from the main menu and then pressing .

Caution: A change in the patient's weight changes the flow rate!







3.3 Drug library

The drug library contains approximately 720 drug names, including related therapy data and information, in 15 categories. Drug information is entered into the pump via the software program "Drug List Editor Space".

Note: The drug library can be started in the startup and the special function menu. Prior to starting the therapy, users must ensure that the drug library stored in the pump matches the target patient group to be treated. The name of the drug library (see headline) is displayed on the pump. There are different options for integrating the drug library into the therapy. Integration can be done while a drug is being administered as well as in the pump's Stop mode.

A drug name with stored therapy data can be selected from the drug library. Or, if a delivery rate, a volume and/or a time were already defined in the main menu, the drug name and the adapted parameters of the data set will be loaded. Even if drug delivery was already started under a dosage rate calculation, it is possible to assign a drug name retroactively

The following describes how to select a drug, including the parameters stored with it:



- Open the drug library by pressing .
- Navigate through the category list with  and select the desired drug from the alphabetical list (all drugs) or within a drug category by pressing .
- Confirm displayed drug information, if applicable, with .
- Check whether the abbreviated drug name in the main menu refers to the selected drug. Check the parameters in the main menu by pressing  and start the infusion with .





Hard Limits:

If the set rate/dosage/bolus volume and bolus rate exceed the hard limits stored in the database, then the drug is rejected, a message appears and the pump returns to the drug selection screen. If this happens during an infusion, the pump continues to deliver the drug.

Soft Limits:

For the same parameters, soft limits can be defined via the Drug List Editor. The pump display shows the following symbols that describe the pump's status with regard to the soft limits:

Infusion is within the minimum and maximum soft limit thresholds	=	
Infusion is within the maximum soft limit threshold	=	
Infusion is within the minimum soft limit threshold	=	

Upper soft limit is exceeded	=	
Lower soft limit is exceeded	=	
No soft limit is defined	=	
Only one drug name is present (it is possible to load only one drug name from the drug library)	=	

The limits of the drug database have to comply with the limits of the pump and the disposable.

Note: For life-supporting drugs, additional patient monitoring is strongly advised.

Note: When a drug is selected from the drug database while the pump is in dosage rate mode, the initial values will be overwritten by those from the drug database.

3.4 Instructions for Use of Bar-coding Using DoseScan™ and the SpaceStation with SpaceCom

If a hospital is utilizing bar-coding for patient identification, staff identification and for labeling of patient medications, it is possible to utilize bar-code scanning in order to perform the following workflow options:

- Scan the barcode containing the clinician's ID into the Perfusor® Space PCA pump and store it in its log file
- Scan the barcode containing the patient's ID into the Perfusor® Space PCA pump and store it in its log file
- Scan the barcodes containing both the patient's and the clinician's ID into the Perfusor® Space PCA pump and store those data elements in its log file
- Scan the patient's ID bracelet, then scan the patient's ID on the medication bag, in order to confirm that the proper medication is being administered to the correct patient (ie patient matching) and store both in the log file.
- Program the Perfusor® Space PCA pump using the DoseScan™ feature, which uses the patient's ID barcode and the barcodes for all of the therapy parameters (ie drug name, concentration, dose) on the medication label, in order to program the infusion therapy. Upon complete scanning, the clinician needs only to confirm the information and start the infusion.

Bar-code scanning requires the use of the B. Braun SpaceStation with SpaceCom and the bar-coding option. Bar-coding can be utilized for any and all pumps contained in the SpaceStation. If a handheld barcode scanner is attached to the SpaceStation with SpaceCom, when a pump is powered on, the first prompt



will be requesting a scan as determined in the pump configuration. If a pump is powered on prior to the barcode scanner being attached to SpaceCom the user will need to select DoseScan™ from the menu.

Scanning with Clinician ID, Patient ID and with Drug entry matched to the parameters in Drug Library.

Prior to beginning bar-code scanning, insure that at least one Perfusor® Space PCA pump is docked into the SpaceStation, and that the pump is charged. A handheld barcode scanner must also be plugged into the SpaceStation. If a handheld barcode scanner is attached to the SpaceStation with SpaceCom, when a pump is powered on, the first prompt will be requesting a scan as determined in the pump configuration. If a pump is powered on prior to the barcode scanner being attached to SpaceCom the user will need to select DoseScan™ from the menu.

- Load Perfusor® Space PCA pump into SpaceStation. Power on the pump by pressing .
- Load the proper syringe into the pump and confirm proper loading.
- The display screen of the pump will display a prompt "Scan Nurse ID" in the center of the display.
- With the handheld scanner attached to the SpaceStation, scan the nurse's ID. The barcode scanner should beep when the barcode is read successfully. The pump will prompt the user for the next required scan.

Note: Once the first scan occurs, the bar-code scanning process has time limits built in that are designed to require that the process occurs continuously within a short period of time. Should a clinician be interrupted during the scanning process, the process will automatically be aborted and the screen returned to the first step.
- Next, on the center of the display the prompt "Scan Patient ID" will appear. Scan the ID barcode on the patient's wristband. The scanner will beep when the barcode is read successfully. The pump will prompt the user for the next required scan.
- Next, the screen will display the prompt " Scan IV Label – Patient". On the medication bag, Scan the Patient ID first, then scan the Drug ID label to program all of the patient's drug therapy. The scanner will beep and all medication information from the barcode label will be loaded into the pump, including the concentration and any dose limits that were included in the drug library information. If for some reason the medication label scanned does NOT match the Patient ID previously scanned, the screen will display a message "Wrong Barcode " and an alarm tone will be heard. The scanning process will not advance until a proper match is obtained between the Patient ID on the wristband and the Patient ID on the medication.

- If a desired parameter is missing from the IV label or was not scanned correctly the pump will prompt the user to scan the missing information.
- If no additional information is available the user can override the request by pressing the directed key.
- The pump will then display the scanned data for confirmation. If so configured and if a match was found between the Drug data on the label and drug information within the Drug Library, the Drug name and other scanned parameters will appear.
- Confirm each scanned element by pressing  to verify and complete the scanning process. Finally, press  to leave the confirmation menu.
- Begin the infusion by pressing . The green LED will illuminate, and the arrows graphic will be displayed in the upper right, indicating that the pump is infusing.

Scanning with only Patient ID Scan Activated:

If a handheld barcode scanner is attached to the SpaceStation with SpaceCom, when a pump is powered on, the first prompt will be requesting a scan as determined in the pump configuration. If a pump is powered on prior to the barcode scanner being attached to SpaceCom the user will need to select DoseScan™ from the menu.

- Load Perfusor® Space PCA pump into SpaceStation. Turn on the pump by pressing .
- Load the proper syringe into the pump and confirm proper loading.
- The display screen of the Perfusor® Space PCA pump will display a prompt "Scan Patient ID".
- With the handheld scanner attached to the SpaceStation, scan the patient's ID. The barcode scanner should beep when the barcode is read successfully.

Note: Once the first scan occurs, the bar-code scanning process has time limits built in that are designed to require that the process occurs continuously within a short period of time. Should a clinician be interrupted during the scanning process, the process will automatically be aborted and the screen returned to the first step.

- Upon completion, press  to verify and complete the scanning process.
- Enter any required information on the therapy, including the Volume to be infused (VTBI) and the rate of infusion or time of infusion. When therapy information is complete, the Start icon will be highlighted in the upper right corner of the display.

- Begin the infusion by pressing . The green LED will illuminate, and the arrows graphic will be displayed in the upper right, indicating that the pump is infusing.
- Alternately, if the pump has been configured to use the Drug Library, you will be prompted to select a drug from the drug library, confirm the selection, enter a dose, and then start the infusion.

Scanning with Patient ID and Patient Matching Activated:

If a handheld barcode scanner is attached to the SpaceStation with SpaceCom, when a pump is powered on, the first prompt will be requesting a scan as determined in the pump configuration. If a pump is powered on prior to the barcode scanner being attached to SpaceCom the user will need to select DoseScan™ from the menu.

- Load Perfusor® Space PCA pump into SpaceStation. Turn on the pump by pressing .
- Load the proper IV set or syringe into the pump and confirm proper loading.
- The display screen of the Perfusor® Space PCA pump will display a prompt "Scan Patient ID" in the center of the display.
- With the handheld scanner attached to the SpaceStation, scan the Patient's wristband ID. The barcode scanner should beep when the barcode is read successfully. The pump will prompt the user for the next required scan.



Note: once the first scan occurs, the bar-code scanning process has time limits built in that are designed to require that the process occurs continuously within a short period of time. Should a clinician be interrupted during the scanning process, the process will automatically be aborted and the screen returned to the first step.

- Next, on the center of the display the prompt "Scan IV Label-Patient" will appear. Scan the ID barcode on the IV label. The barcode scanner should beep when the barcode is read successfully.
- If, for some reason, the Patient ID on the medication label scanned does NOT match the Patient ID previously scanned, the screen will display a message "Wrong Barcode " and an alarm tone will be heard. The scanning process will not advance until the proper match is obtained between the Patient ID on the wristband and the Patient ID on the medication..
- Upon completion, press  to verify and complete the scanning process.
- Enter any required information on the therapy, including the Volume to be infused (VTBI) and the rate of infusion or time of infusion. When

therapy information is complete, the Start icon will be highlighted in the upper right corner of the display.





- Begin the infusion by pressing . The green LED will illuminate, and the arrows graphic will be displayed in the upper right, indicating that the pump is infusing.

OPTIONS

You can select and change the option functions during therapy or if the infusion is interrupted. To edit a menu item, select "options" in the main menu and press . Then select the desired function with  and follow the instructions as described.

4.1 Occlusion pressure

The higher the pressure level is set, the higher the system pressure has to rise to trigger a pressure alarm.

- Select pressure in the options menu by pressing .
- Select between nine pressure levels (1=lowest level; 9=highest level) by pressing  or  and confirm with .

4.2 Data lock

The data lock function protects the device from unauthorized access. A four-digit code, which can be changed in the service program, activates this function. There are three lock levels.

Level 1:

Values or bolus cannot be changed, but syringes can be. Navigation is allowed through all menus and status data can be queried. The pump can also be started, stopped and shut down.

Level 2:

This level has the same permissible options as Level 1, but does not permit the syringe to be changed. To prevent a data lock alarm, the user has to enter the correct code within 20 seconds after the pump was stopped. Only after entering the code can the syringe be changed and the pump turned off.

Level 3:

This level allows the pump to be started and stopped as well as shut down. The code for this level can be different for each drug and is defined in the drug library. However, the syringe can be changed with the code that is used for the other levels. The following table lists the different options for Levels 1, 2 and 3:

Action/Event	Level 1	Level 2	Level 3
Change syringe	✓	✗	✓ with code for level 1/2
Infusion start	✓	✗	✓
Change in the parameters	✗	✗	✗
Infusion stop	✓	✓	✓
Pump shut-down/standby	✓	✗	✗
PCA bolus with pump-based bolus	✗	✗	✓
Customizable Screen	✗	✗	✓
Audible feedback with bolus request	✗	✗	✓
Indicates rejected PCA boluses	✓	✓	✗

✓ = Possible | ✗ = Not possible | = Followed by "standby" alarm

Activation of the function:

- Select data lock in the options menu by pressing .
- With and switch between Level 1, 2 or 3 (if activated) and confirm with .
- Enter code with and press to activate the data lock function.

The values as well as the bolus function, which is identified by , can only be changed by entering the code. From the overviews, main status, special functions and options menus, the lock is reactivated after 20 seconds. If the code is incorrectly entered twice, the pump switches back to the last menu. If the code is again entered incorrectly twice, the pump sounds an audible alarm, triggers a nurse call and the yellow LED begins to blink. If the target value is reached while the data lock is active, a restart is only possible after entering the code.

To deactivate the function, select "Off" from the data lock function list, press , enter the code and confirm again with .



4.3 Bolus rate

- Select bolus rate in the options menu by pressing .
- Change the bolus rate with and confirm setting with .

Note: Adjust the bolus rate to the therapy requirements. Take care not to overdose! For very high bolus rates (e.g. 1800 mL/h), 5 mL is administered within just one second.





4.4 KVO mode (Keep Vein Open)

After the pre-selected volume to be infused or the pre-selected time has run out, the pump can continue delivering at a pre-defined KVO rate (see Technical data). The duration of the KVO delivery is defined in the service program.

- Select KVO mode in the options menu with .
- Answer yes/no question with  to activate KVO mode.





4.5 Contrast / Display Illumination / Keypad Illumination

Contrast, display and keypad illumination can be adjusted individually according to lighting conditions.





- Select contrast/display illumination/keypad illumination in the options menu by pressing .
- Select between the 9 contrast and display illumination levels with  or  and confirm with . If light-sensitive drugs are used, you can also completely turn off the keypad or the syringe illumination

4.6 Alarm Volume

There are 9 different volume levels to choose from.



- Select volume in the options menu by pressing .
- Confirm volumes with  or  and confirm with .

4.7 Date / Time

- Open date/time in options menu by pressing .
- Press  or  to change date/time and confirm the setting with .

4.8 Macro mode





The delivery rate appears larger on the display when macro mode is activated and the pump is infusing.

- Select macro mode in the options menu with .
- Answer yes/no questions by pressing .

Quick selection of the macro mode: While the pump is administering the drug, press  and hold down until the font size changes.

ALARMS

The Perfusor® Space PCA is equipped with an audible and optical alarm signal.

Alarm type	Audible signal	Optical signal			Staff Call	User confirmation
		Red LED	Yellow LED	Text		
Device alarm	Yes	flashes	flashes	Device alarm and alarm code (see service manual)	Yes	Press  and follow the instruction on the display.
Operating alarm	Yes	flashes	flashes	See alarm description	Yes	Press  to acknowledge the audible alarm, alarm text and nurse call. The red LED remains on until the infusion is restarted.
Pre-alarm	Yes	off	flashes	See alarm description	Can be (de) activated via the service program	Press  turns off the alarm and turns off the nurse call.
Reminder alarm	Yes	off	flashes	See alarm description	Yes	Press  turns off alarm tone as well as nurse call and deletes alarm text.
Alarm reference	No	off	off	See alarm description	No	Instructions deleted without confirmation.

5.1 Device alarms

In case of a device alarm, the infusion is immediately stopped. Press  to turn off the device. Then turn the device back on. If the device alarm comes on again, disconnect the patient's IV line, open front cover and remove the syringe. The device must then be serviced.

5.2 Pre-Alarms and operating alarm

Pre-alarms:

Pre-alarms occur several minutes (regardless of service settings) prior to the operating alarms. With pre-alarms, an audible signal sounds, the yellow LED blinks and the staff call (optional) is issued. The display varies depending on the cause of the pre-alarm. The signal tone and staff call are turned off by pressing . The screen display and LED remain in pre-alarm mode until the operating alarm initiates. If multiple pre-alarms are triggered simultaneously, the staff call and the audible signal do not go off until the last pre-alarm is exited. Pre-alarms do not cause drug delivery to stop.

Display message	Cause of pre-alarm
"Syringe almost empty"	Little infusion solution left in the syringe.
"VTBI almost reached"	Pre-selected volume almost infused.
"Time near end"	Pre-selected time almost expired.
"Battery nearly empty"	Battery almost completely discharged.
"KVO active"	VTBI/time are expired and pump continues to run at KVO rate.
"Communications error"	The pump is integrated into a system in which one device is incompatible or defective. Operation of this pump is not permitted in the system. The system has to be checked by a service technician.

A countdown clock in the display counts down the remaining pre-alarm time (3 to 30 minutes, depending on service program). Afterward, the pump goes into operating alarm mode.

Pre-alarms "VTBI" almost reached" (volume pre-selection) and "Time near end" (time pre-selection) can be (de) activated via the service program.

Operating alarms:

When operating alarms occur, the infusion stops. An audible signal sounds, the red LED blinks and a nurse call is issued. The display shows "alarm" and the cause of the alarm. The signal tone and nurse call can be turned off by pressing . Corrective actions must be implemented based on the cause of the alarm.



Display message	Cause of pre-alarm and corrective measures
"Syringe empty"	No remaining infusion solution in the syringe. Due to different manufacturing syringe tolerances, some liquid may remain in the syringe. Restarting results in the syringe being completely emptied and shuts down via the pressure sensor. Change the syringe as described under 1.4.
"VTBI infused "	Pre-selected "VTBI" is infused. Continue with therapy or select new therapy.
"Time expired"	Pre-selected time has expired. Continue with therapy or select a new therapy.
"Battery empty"	The battery is discharged. Connect device to power supply and/or change battery. Battery alarm sounds for 3 minutes. Afterward, the pump shuts itself off.
"Pressure high"	Occlusion in the system has occurred. The set pressure level has been exceeded. The pump automatically reduces the bolus. Check whether the syringe is empty, make sure the line is free of kinks and undamaged, and that IV and filter are clear.

	If applicable, increase the threshold pressure settings. Due to different syringe tolerances, a pressure alarm can go off depending on the high syringe frictional forces.
"KVO finished"	KVO time has expired. Continue with therapy or select new therapy.
"Syringe not correctly inserted"	The syringe tabs are not properly positioned and syringe not properly secured. Insert as described under "Overview of Perfusor® Space" as well as 1.1.
"Syringe holder"	The syringe holder was opened during an infusion. Close the syringe holder.
"Battery cover removed"	The battery cover is not properly attached to the battery compartment. When closing the battery cover, make sure you hear it snap in.
"Drive blocked"	The drive head was blocked from moving forward due to an external interference. Take care to avoid obstructions.
"Calibrate device"	Pump calibration data have changed (e.g. after an update). Recalibrate device with service program.
"Claw malfunction"	The emergency release button was pressed and the claw manually opened. Remove syringe and inform technical service.
"Plunger plate has no contact"	The syringe's plunger plate has no contact to the plunger plate sensor. Check system for low pressure and remove the cause of low pressure.
"Standby time expired"	The standby time has expired. Enter new time or continue with the previous therapy.
"No battery in the device"	Pump operation without battery is not possible. Turn off pump and insert battery as described in "Overview of Perfusor® Space."
"Data was reset"	Therapy and pump settings could not be restored. Re-enter therapy and pump data.
"Therapy data was reset"	Therapy data could not be restored. Re-enter therapy.
"Data lock"	Someone attempted to stop or turn off the pump without entering the code. Enter the correct code to continue with the therapy or to turn off the pump. The red LED does not go off until drug delivery begins or after the pump is turned off.

Caution: If a wrench appears and/or the yellow, red and blue LEDs blink, this means that the pump is in service mode and can not be used on the patient. The pump must be checked by a service technician.

5.3 Reminder alarms

Reminder alarms occur in two cases:

1. A syringe is inserted, the pump does not deliver, no value is edited and the device is not operated for two minutes.
A signal tone sounds, the yellow LED blinks and a staff call is issued.
 - a) The display shows "Reminder alarm!"
 - b) The display shows "Configuration not completed!"Confirm alarm with  and continue by pressing therapy entry/start-up.
2. Value entry was begun, but not completed and confirmed. This is also possible in the case of a missing syringe. A signal tone sounds, the display shows "Value not accepted," the yellow LED blinks and a staff call is issued. Confirm alarm by pressing  and continue with therapy entry.

5.4 Alarm instructions

In case of incorrect entries, the display will show relevant instructions (e.g. "Caution: rate is out of range" or "The parameter cannot be changed") and a signal tone sounds. These warnings disappear after a few seconds without having to be confirmed.

BATTERY OPERATION AND MAINTENANCE

The Perfusor® Space PCA is equipped with a NiMH-battery that has a operating life-time of 8 hours at 25 mL/h delivery rate. For optimal life of the battery, the device is equipped with protection against overcharging and over-discharging. The device charges the battery when plugged into the wall outlet. In case of a power outage or removing the power supply, the pump automatically switches over to battery operation.

Note: If the pump is stored unused for a longer period (> 2 weeks), the battery should be completely charged and then removed from the pump. Before changing the battery, the patient line has to be disconnected and the pump shut off.

The battery status display indicates the battery power (low, medium, high). More detailed information on the battery capacity (operating time in hours and minutes) can be found in the menu item "Battery capacity" in the status menu of the Perfusor® Space.

Important information for the battery self-test:

If the battery status symbol blinks while operating from the wall outlet, the battery is either discharged or used up. In this case, the pump should not be disconnected from power. If the pump has to be disconnected from power because of an emergency, check to make sure that the battery capacity is sufficient for intended use. If the battery status icon blinks continuously (> 1 h), the battery must be checked by a technician and replaced if necessary.

Tips for optimal battery operation:

The service life of a battery can vary due to

- Ambient temperature
- Varying load (e.g. frequent boluses).



You can extend the battery's service life by completely discharging it and then fully recharging it from time to time. For this purpose, the pump has to be operated in battery maintenance mode from time to time. To subsequently charge the battery, the pump has to be connected to the power supply for at least 6 hours. This procedure should be performed once a month. Moreover, please observe the following:

- If possible, only charge the battery if it was completely discharged.
- If a battery that was not completely discharged is charged multiple times, this then reduces its capacity. Its original capacity can be achieved again by completely discharging the battery and then recharging it.
- Under normal temperature conditions, a battery can be charged 500 times on average and then discharged again until its service life decreases.
- If the pump is not connected to the wall outlet, the battery discharges and can be fully depleted after a month, even when the device is not in operation. If this happens, the battery cannot reach its original capacity after just one charging, rather it will take multiple cycles of charging and discharging.
- Optimal battery life can only be achieved if the battery is kept charged and the pump is in continual operation at room temperature. The pump's battery display

is an approximate value based on the current delivery rate. If the battery begins to show signs of fatigue, its "battery display" can differ from the currently achievable operating time.

Caution: Batteries can explode or leak if they are opened or burned. Therefore, please follow appropriate disposal regulations in your institution.

Battery maintenance:

To accurately maintain battery capacity, routine battery maintenance is necessary. It is advised that battery maintenance be performed every 30 days as a standard procedure. Routine battery maintenance can determine possible capacity loss (e.g. through battery's aging) and rebalances capacity/duration. To initiate the discharge procedure, after turning off the pump, the following notification appears on the display "Battery maintenance" and the -button. By pressing  and , discharge is initiated. If the pump is turned on again, this procedure is interrupted. To continue battery maintenance, it has to be reactivated. After complete discharge, the battery must be completely recharged again. The entire battery maintenance procedure takes about 12 hours.

Caution: When pump is started, please make note of the shortened battery run-time in the event that the battery maintenance procedure was not completed.

COMPATIBLE SYRINGES

The syringe types listed in the following tables can be used with the Perfusor® Space PCA. Because B. Braun has no influence on the quality of syringe items from other manufacturers, quality inconsistencies can lead to changes in the technical properties of the pump. B. Braun is not liable for deviations caused by the use of syringe from manufacturers other than B. Braun's approved table. In case of such quality fluctuations, please contact the syringe manufacturer.

Please refer to the listed item number (Item No.¹⁾ to be sure of specific brand compatibility.

The alarm actuation times²⁾ after a system breach were measured at 5mL/h. All measured data in the tables are typical average values that can deviate above and below due to possible syringe variations.

Manufacturer: B. Braun

Syringe Type B. Braun	Omnifix™ 2/3 mL	Omnifix™ 5 mL	Omnifix™ 10 mL	Omnifix™ 20 mL	Omnifix™ 30 mL	Omnifix™ 50 mL
Mat. no. ¹⁾	461 0303-02	4617053V-02	4617100V-02	4617207V-02	4617034F-02	4617509F-02
Time to Occl. ²⁾	typ.	typ.	typ.	typ.	typ.	typ.
P 1 [mm:ss]	0:39	0:58	0:47	1:04	1:13	1:16
P 9 [mm:ss]	1:05	1:32	2:08	3:26	6:07	13:46

Manufacturer: Covidien AG

Syringe Type TYCO USA	Monoject® 3 mL	Monoject® 6 mL	Monoject® 12 mL	Monoject® 20 mL	Monoject® 35 mL	Monoject® 50/60 mL
Mat. no. ¹⁾	118030777	8881-516937	8881-512878	8881-520657	8881-535762	8881-560125
Time to Occl. ²⁾	typ.	typ.	typ.	typ.	typ.	typ.
P 1 [mm:ss]	0:41	0:50	1:07	1:13	1:27	1:35
P 9 [mm:ss]	1:17	2:07	3:45	4:49	11:50	15:46

Chapter 7

Manufacturer:
Becton
Dickinson

Syringe Type B-D EU/USA	Plastipak® 3 mL	Plastipak® 5 mL	Plastipak® 10 mL	Plastipak® 20 mL	Plastipak® 30 mL	Plastipak® 50/60 mL
Mat. no. ¹⁾	309585	309603	309604	309661	309650	309653
Time to Occl. ²⁾	typ.	typ.	typ.	typ.	typ.	typ.
P 1 [mm:ss]	0:53	0:55	1:15	2:05	2:14	2:53
P 9 [mm:ss]	1:15	1:34	3:37	6:30	6:36	15:34

Manufacturer:
TERUMO

Syringe Type TERUMO USA	3 mL	5 mL	10 mL	20 mL	30 mL	60 mL
Mat. no. ¹⁾	3SS*03L	3SS*05L	3SS*10L	3SS*20L	1SS*30L	3SS*60L
Time to Occl. ²⁾	typ.	typ.	typ.	typ.	typ.	typ.
P 1 [mm:ss]	0:43	0:35	0:55	2:12	2:25	3:34
P 9 [mm:ss]	1:17	1:16	4:48	7:53	8:18	17:03

Manufacturer:
NeoMed*

Syringe Type NeoMed	NeoMed 3 mL	NeoMed 6 mL	NeoMed 12 mL	NeoMed 20 mL	NeoMed 35 mL	NeoMed 60 mL
Mat. no. ¹⁾	NM-S3EO	NM-S6EO	NM-S12EO	NM-S20EO	NM-S35EO	NM-S60EO
Time to Occl. ²⁾	typ.	typ.	typ.	typ.	typ.	typ.
P 9 [mm:ss]	01:18	01:47	03:33	05:51	08:46	13:31
Flow rate variance 1mL/h	-0,43 - 4,65%	0,11 - 1,86%	-3,97 - 0,07%	3,34 - 3,20%	-7,14 - 0,34%	-6,73 - 7,62%

- * - Consider the risks involved in the use of a Luer Slip connection prior to the therapy.
- observe permanently the connection between the NeoMed Luer Slip syringe and the infusion set, in order to detect any lack in the connection.
 - Flow rate variance up to + - 8,00%
 - Use NeoMed syringes only for Enteral Nutrition

START UP GRAPHS AND TRUMPET CURVES

Start Up Curves

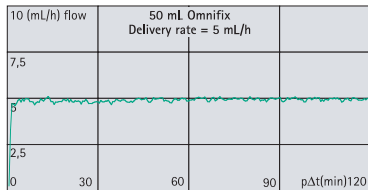
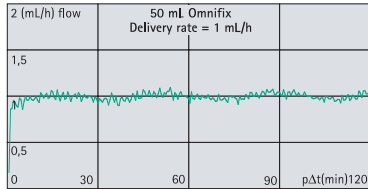

Trumpet Curves

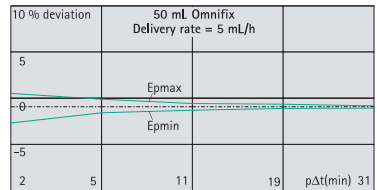
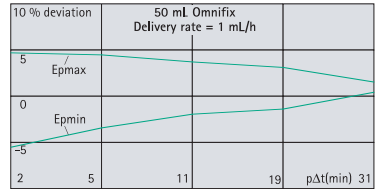

These graphics show the accuracy/uniformity of the flow, depending on the time. Take the following into account in the process: The flow behavior or the delivery accuracy is influenced essentially by the syringe types (syringe items). When using syringe types other than the ones mentioned under the order data (syringe items), deviations in pump performance cannot be ruled out.

Trumpet Curves

Each value measured in the second hour.

Measurement interval $\Delta t = 0.5 \text{ min}$

Monitoring interval $p \times \Delta t \text{ [min]}$

Start-up Curves

Measurement interval $\Delta t = 0.5 \text{ min}$

Measurement duration $T = 120 \text{ min}$

Flow $Q_i \text{ (mL/h)}$

TECHNICAL DATA

Device type	Infusion Syringe Pump
Classification (according to IEC/EN 60601-1)	<input checked="" type="checkbox"/> defibrillation-protected; Type CF <input type="checkbox"/> protection rating II; protection rating I combined with SpaceStation
Class (in accordance to guideline 93/42 EEC)	IIb
Moisture protection	IP 22 (protected from drip water if positioned horizontally for general use)
External power supply:	
■ Rated voltage	via B. Braun SpaceStation or optional with separate power cord (rated voltage 100 ... 240 V AC~, 50/60 Hz) for stand alone operation
■ External low voltage	11 ... 16 V DC --- via Connection cable SP 12 V or via SpaceStation
Staff call	Max. 24 V / 0.5 A / 24 VA (VDE 0834)
EMC	IEC/EN 60601-1-2 / 60601-2-24
Time of operation	100 % (continuous operation)
Operating conditions:	
■ Relative humidity	30 % ... 90 % (without condensation)
■ Temperature	+5 ... +40 °C
■ Atmospheric pressure	500 ... 1060 mbar
Storage conditions:	
■ Relative humidity	30 % ... 90 % (without condensation)
■ Temperature	+5 ... +40 °C
■ Atmospheric pressure	500 ... 1060 mbar
Battery type (re-chargeable)	NiMH
Battery run-time	Approx. 8 hours at 25 mL/h
Recharge time	Approx. 6 hours
Weight	Approx. 3.08 lbs. = Approx 1.4 kg
Dimensions (W x H x D)	Approx 9.8X2.6X5.9 inches = Approx 249 x 68 x 152 mm
Pre-selected volume	0.1 - 99.99 mL in increments of 0.01 mL 100.0 - 999.0 mL in increments 0.1 mL 1,000 - 9,999 mL in increments 1 mL
Pre-selected time	00:01 - 99:59 h
Delivery accuracy	± 2 % according to IEC/EN 60601-2-24

Occlusion alarm button	9 stages from 75 mmHg to 900 mmHg
Alarm sounds in case of incorrect delivery	In case of incorrect dosage of 0.1 mL due to a pump malfunction, the pump turns off automatically
Technical inspection (Safety check)	Every 2 years

Adjustable delivery rates	Syringe sizes	Cont. Rates*	Bolus Rates
	[mL]	[mL/h]	[mL/h]
	50/60	0.01 - 200 Optional 0.01 - 999.9	1 - 1800
	30/35	0.01 -100	1 - 1200
	20	0.01 -100	1 - 800
	10/12	0.01 -50	1- 500
	5/6	0.01 -50	1 - 300
	2/3	0.01 -25	1 - 150

Delivery rates increments	0.01* - 99.99 mL/h in stages from 0.01 mL/h 100.0 - 999.9 mL/h in stages from 0.1 mL/h
Delivery accuracy with bolus	typ. ± 2 %
Max. bolus volume according to bolus reduction	≤ 0.2 mL
KVO rate	Rate ≥ 10 mL/h: KVO rate 3 mL/h Rate < 10 mL/h: KVO rate 1 mL/h Rate < 1 mL/h: KVO rate = set rate (factory default setting 0.1 mL/h)
PC (Computer) connection	USB connection with B. Braun port cable (8713230) with galvanic separation. Please pay attention to safety instructions.
History log	1,000 most recent history entries 100 events for system diagnosis You can find more information from the separate documents on the History Viewer

*Factory pre-setting allows delivery rates to be entered starting at 0.1 mL/h.

WARRANTY / TRAINING / TSC* / SERVICE / CLEANING / DISPOSAL

Responsibility of the Manufacturer

The manufacturer, assembler, installer or importer is only responsible for the impact on safety, reliability and performance of the device if:

- Assembly operations, upgrades, new settings, changes or repairs are performed by persons they have authorized
- Electrical installation in the relevant room complies with the VDE 0100, 0107 or IEC requirements and national specifications
- The device is used in accordance with the Instructions for Use,
- and the safety checks are performed regularly as recommended.

Warranty

The CE mark confirms that this medical product complies with the "Council Directive on Medical Devices 93/42/EEC" dated 14th June 1993.

B. Braun
Melsungen AG

For each Perfusor® Space PCA, B. Braun offers a 12-month warranty starting from the delivery date (12 months for each SP battery package). It covers maintenance or the replacement of damaged parts, whether it is the result of design, manufacturing or material errors. The warranty becomes void if the owner or an unauthorized third party performs changes to or repairs on the device.

- Excluded from the warranty: Coverage for problems that are traced back to incorrect usage, improper handling or normal use. Consult warranty documents for specific terms of use.
- B. Braun accepts defective batteries for proper disposal.

Training

B. Braun offers training and in-servicing. Please ask your local representative for more details.

Technical Safety Check* / Service

The technical safety check is required every two years, and should be documented. Service work may only be performed by technicians authorized or trained by B. Braun.

Routine Checks

Check regularly for cleanliness, completeness and signs of damage. Operate according to this Instruction for Use. The pump has to run through the power-

on test each time a syringe is changed. When turning on, check self-check, alarm sound, operating and alarm check displays.

Cleaning

Clean using mild soapy water. Do not use spray disinfectant on the power cable and plug. Use cleaner/disinfectant available from your supplier that meets your requirements per your housekeeping protocol. If necessary, choose a disinfectant cleaner based on the following make ups:

1. A solution containing a = 50% concentration of 70% Isopropyl alcohol. (Isopropanol)
2. A solution containing a = 0.3% concentration of ammonium chloride.

Always apply the solution with a soft low-lint applicator dampened, not saturated, with the product. Never spray the product directly onto the pump. Follow the disinfectant's product label for disinfectant times. After the disinfection period, remove residual chemicals by wiping the device twice with a low lint applicator dampened, not saturated, with fresh water.

After cleaning, allow the device to dry for at least 20 minutes prior to use. Do not spray into openings in the device. Be sure to observe state and local regulations concerning proper waste and disposal for batteries and disposables. Wipe magnifying and display glass on front door of pump only with a soft cloth.

Disposal

B. Braun accepts pumps as well as batteries for proper disposal. To dispose of syringe as well as infusion solutions, follow applicable hygiene and disposal regulations provided by your institution.

Inspection on Delivery

The pump is carefully packaged, but damage during shipment can occur. Please check that items are present after unpacking. Do not put a damaged device in operation. Notify service.

Included in Delivery

Perfusor® Space PCA, SP battery pack, Instructions for Use, Locking Syringe Cap, Key, and Bolus cord.

INSTRUCTIONS FOR USE ACCESSORIES

SpaceStation (8713140U)

Station for holding up to four pumps. For more information, please refer to the SpaceStation user manual.

SpaceCover Comfort (8713145U)

Cover for placing on the top of the SpaceStation, includes center carrying handle and includes a central alarm management and alarm LED's.

PoleClamp SP (8713130)

Maximum three B. Braun Space pumps can be stacked on top of one another, secured and transported with the SP pole clamp. To securely attach the SP pole clamp, please observe the "Perfusor® Space PCA Overview" and "Patient Safety."

Power Supply SP (8713112A)

The Power Supply SP is adequate to supply power for a single pump or up to three pumps when using a Combi Lead SP (8713133).

- 1.) Plug the AC adapter into the P2 socket on the back of the pump (listen for audible snap-in).
- 2.) Connect the power plug to the power supply.

Note: To remove from the pump, press the lever on the plug. A maximum of three plugs can be inserted into the P2 socket above one another.

Technical data: 100 – 240 V AC~, 50/60 Hz

Combi Lead SP Cable 12 V (8713133)

Use the Combi lead SP combination cable to connect up to three pumps. All pumps can be operated via the SP connection line (12 V).

- 1.) Connect the combination cable plug to the P2 socket on the back of the pump.
- 2.) Connect the SP connection line to the SP combination cable.
- 3.) Plug connector of the SP connection line into the 12 V socket.

Note: A maximum of three plugs can be plugged into the P2 socket on top of one another.

Space PCA Kit (8712554)

Consists of :

- Patient demand bolus cord
- Velcro strap for attaching the bolus cord around the patient's arm
- Clip to attach the bolus cord to the Velcro strap
- Metal clip for attaching the bolus cord to the bed sheet
- Cable strap for wrapping the cable of the bolus cord
- PCA-Key for locking the syringe holder or the Syringe Anti Removal Cap

Syringe Anti Removal Cap PSP (REF 8713556)

The Syringe Anti Removal Cap PSP is slid over the drive head from the front and is locked with the PCA-key by turning the key in a 270° clockwise rotation. View the markings on the cap to ensure it is securely locked. Dismantling: rotate key 270° counter clockwise. Push to the left and disengage.

Caution: When Syringe Anti Removal Cap is used always change the syringe as soon as the "syringe empty" alarm appears.

Battery Pack incl. Pin (NiMH) (8713180A)

For more information on the SP battery pack, see "Battery Operation."

Interface Lead CAN SP (8713230)

The Interface Lead CAN SP is needed to establish a connection between the SpaceStation/Pump and the computer output for servicing.

- 1.) Plug connector into the F2 socket on the SpaceStation or P2 on the pump and connect this with the CAN/USB converter.
- 2.) Connect the CAN/USB converter with the computer output as described in the relevant user manual.

Caution: Interface Lead CAN SP is only meant for servicing; do not use during patient application.

Note: A maximum of three connectors can be connected on top of one another in the P2 socket.

Connection Lead for Staff Call SP (8713232)

The SP nurse call connection line has to be used to connect the Perfusor® Space to a call system. The call system must comply with the provisions of the VDE 0834 (note country-specific regulations).

Note: Prior to each application, test the nurse call signal to make sure it works.

The Perfusor® Space PCA offers three different nurse call operating modes. They are shown in the signalization diagram. When selecting an operating mode, pay attention to the technology of the nurse call system. The operating mode can be set via the service program.

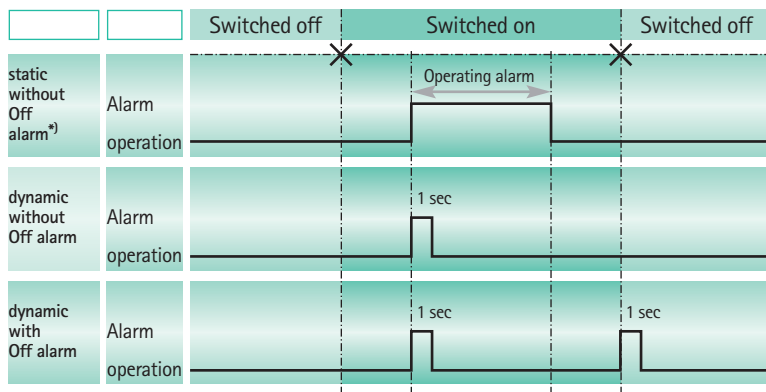

*) in static without Off alarm, nurse call can be suppressed by pressing 

Caution: Because the staff call can fail and may remain unnoticed, the user is responsible for monitoring the local alarms. (Staff call is not checked during the pump self-test.)

Note: A maximum of three connectors can be plugged into the P2 socket on top of one another.

Technical Data

	Connecting Wire	
	White and Green	White and Brown
Alarm	disconnected	connected
Operation	connected	disconnected

Polarity of connections is arbitrary:
max. 24 V / 0.5 A / 12 VA

	Art. No.
B. Braun Perfusor® Space PCA	871 3080U
Recommended accessories for the Perfusor® Space:	
SpaceStation	8713140U
SpaceCover Comfort	8713145U
PoleClamp SP.....	8713130
Power Supply SP (US Plug).....	8713112A
Combi Lead SP Cable 12 V.....	8713133
Battery Pack incl. Pin (NiMH).....	8713180A
Interface Lead CAN SP	8713230
Connection Lead for Staff Call SP	8713232
Space PCA Kit.....	8712554
Syringe Anti Removal Cap PSP.....	8713556
Omnifix™ Syringes:	
Omnifix™ 50/60 mL Luer Lock	4617509F-02
Omnifix™ 30 mL Luer Lock.....	4617309F-02
Omnifix™ 20 mL Luer Lock.....	4617207V-02
Omnifix™ 10 mL Luer Lock.....	4617100V-02
Omnifix™ 5 mL Luer Lock.....	4617053V-02
Omnifix™ 2/3 mL Luer Lock	4610303-02
Microbore tubing with male and female luer locks:	
36", 0.023" ID. Priming volume: 0.3 mL.....	V6510
60", 0.023" ID. Priming volume: 0.4 mL.....	V6512
60", 0.023" ID. with 22 ga. Protected Needle. Priming Volume: 0.4 mL.....	V6512-22
60", 0.050" ID. Priming volume: 2.5 mL. Use with higher flow rates and viscous fluids:.....	V6516
Microbore Extension sets with PVC free fluid path, male and female luer locks:	
36", 0.02" ID. Priming volume: 0.3 mL.....	V6200
36", 0.03" ID. Priming volume: 0.6 mL. Use with higher flow rates and viscous fluids:.....	V6230
60", 0.02" ID. Priming Volume: 0.5 mL.....	V6212
60", 0.02" ID with 22 ga. Protected Needle. Priming Volume: 0.5 mL.....	V6212-22
60", 0.003" ID. Priming volume: 0.8 mL Use with higher flow rates and viscous fluids:.....	V6213
60", 0.03" ID. Priming volume: 1.3 mL with 0.2 micron filter	V6215

Technical Support

If the pump fails to respond to the operating or troubleshooting procedures listed in this Instructions for Use and the cause cannot be determined, discontinue use and forward it to an authorized B. Braun Service Center.

Should it be necessary to return the pumps for repair, contact Technical Support at B. Braun Customer Support at (800) 627-PUMP (7867). A Returned Materials Authorization number will be provided. Carefully pack up the pump (preferably in the original packing), and ship to the address below. B. Braun can not assume any responsibility for loss or damage to returned instruments while they are in transit.

Service and product performance information, operation training, service training, and service manuals may be obtained from the manufacturer by contacting:

B. Braun Medical Inc.

1601 Wallace Drive, Suite 150

Carrollton, TX 75006

Attn: Service Manager

or call (800) 627-PUMP (7867)

Product complaints may be sent to the Quality Assurance Manager at the above address.

With each complaint, please include:

- the pump's serial number and software revision,
- a description of the difficulty experienced,
- the pressure limit setting,
- the rate setting,
- the initial volume(s) to be infused,
- the amount of time between the start of the infusion and the time the difficulty was noticed,
- the message displayed at the time the difficulty occurred,
- the catalog and lot number of the set(s) in use,
- the diagnostic code (if applicable), and
- any other information which may aid in the investigation of the complaint.

Authorization to return products must be received from B. Braun prior to shipment. Please contact Customer Service at the above phone number for a Returned Materials Authorization Number.

Clinical Support

The customer may speak with a Registered Nurse for the clarification of operating instructions or clinical applications for the Space/Pump/etc. A (Clinical Support Specialist) Nurse Consultant may be reached at (800) 854-6851.



Manufactured by:
B. Braun Melsungen AG
34209 Melsungen
Germany
Tel +49 (0) 56 61 71-0

38911893
Printed on 100% chlorine-free bleached chemical pulp
1110 • Date of last revision: November 2010

Distributed by:
B. Braun Medical Inc.
Bethlehem, PA 18018-3524 USA
www.bbraun.com
Clinical and technical support
for USA and Canada:
1-800-854-6851